



Architectural Shingle Lines

Performance Engineered
Sustainably Designed
Roofing Shingles

WHEN IT MATTERS™

All-Weather Performance NEX® Polymer Modified Asphalt

Resists Algae 3M™ Copper Granules **Reduces Air Pollution** 3M™ Smog-Reducing Granules

Reduces Landfill Waste Upcycles Tires & Plastics **Resists Impact** Up to Class 4



Family Built

"A family business based in Oregon since 1956, we at Malarkey Roofing strive simply to make the best shingle in the least environmentally impactful way."

Gregory Malarkey
President, Malarkey Roofing Products

PERFORMANCE

MALARKEY® ARCHITECTURAL SHINGLE

Made with NEX® Polymer Modified Asphalt Technology

NEX® POLYMER MODIFIED ASPHALT

Asphalt core of shingle is rubberized with synthetic rubber polymers (SBS) to enhance shingle strength, flexibility, and resilience.

Up to Class 4 impact rating.
Insurance discounts may apply.

UPCYCLED RUBBER & PLASTIC

Polymers from recycled rubber and plastic improve shingle durability while diverting the equivalent of ~5 rubber tires and ~3,200 plastic bags from the landfill per average-size roof.¹

MORE ADHESIVE BONDS

Synthetic rubber adhesive (SEBS) resists dry-out and delivers extreme seal-down strength against high winds, wind-driven rain, and delamination.

Up to 50% more laminate bonds [3 versus 2] and 2X the rain seals of standard shingles.

3M™ SMOG-REDUCING GRANULES

Clean the air of emission pollutants
Each average-size roof has the smog-fighting potential of ~2 trees.²

THE ZONE® LARGER NAILING AREA

Wider nailing lines on top of the shingle, with longer and tapered bottom shingle backing, create a bigger target for nails to penetrate BOTH shingle layers — critical for helping prevent blow-offs and leaks from troughing.
Up to 2x wider nailing area than standard shingles.

FIBERGLASS MAT

Provides structural reinforcement. 10-55% greater tear strength than the industry standard [ASTM D3462].

3M™ ROOFING GRANULES

Ceramic-coated granules protect shingle from weather and UV aging. Up to 65% greater granule adhesion than the industry standard [ASTM D3462].

3M™ COPPER GRANULES

Reduce black streaks caused by algae growth.
Up to Limited Lifetime algae warranty.

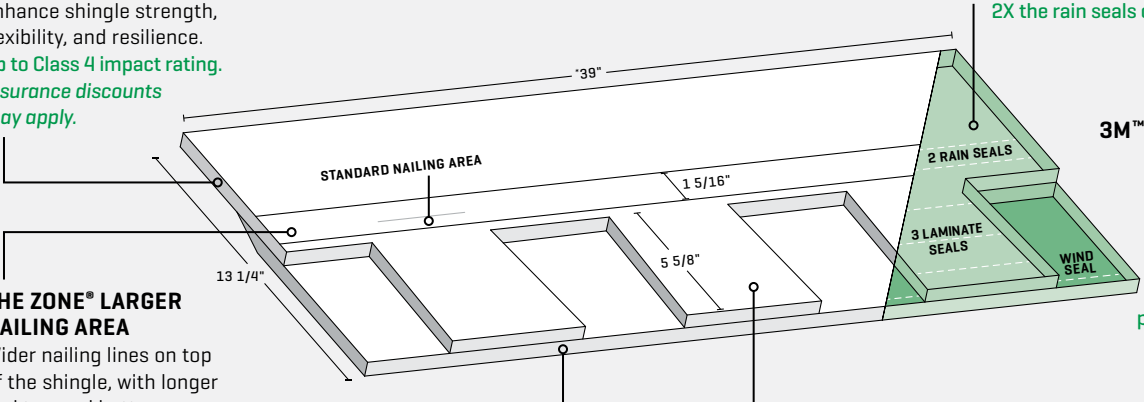

*LEGACY™ SHINGLES 40" LONG.



Clean Air

“Along with planting more trees, we view smog-reducing technology, embedded into mainstream roofing materials, as a great step forward in addressing air quality.”

*Jonathan Parfrey
Executive Director, Climate Resolve*

SUSTAINABILITY

PERFORMANCE ENGINEERED

All-Weather Performance – Shingles are in a constant state of expansion and contraction caused by changing temperatures. Unlike standard shingles, which prematurely become brittle and crack from the stress, NEX® Polymer Modified Asphalt Technology rubberizes shingles for enhanced all-weather strength, flexibility, and resilience to better withstand temperature swings and weather extremes.

Resists Impact – Synthetic (SBS) and upcycled rubber and plastic polymers add durability, tear strength, and industry-leading impact protection from hail and storm debris. Malarkey shingles include up to Class 4 impact protection (highest rating possible), and may be eligible for insurance discounts.

Resists Wind & Rain – Six bonds (3 laminate, 2 rain, 1 wind) of proprietary synthetic rubber adhesive (SEBS), coupled with The Zone®, our patented wider nailing area, seal shingles and block out wind and wind-driven rain. Wind warranties from 110-130 mph.

Resists Algae – Blend of algae-resistant granule options, including 3M™ Copper Granules and shingles featuring Scotchgard™ Protector, help prevent unsightly black streaks.

Resists Fire – Shingles meet highest fire rating (Class A).

SUSTAINABLY DESIGNED

Lasts Longer – Granules are a shingle’s primary line of defense. Polymer rubberization enhances asphalt’s natural thermo-cycling resilience and grip, resulting in up to 65% greater granule adhesion than the industry standard [ASTM D3462], and longer product life.

Reduces Air Pollution – 3M™ Smog-Reducing Granules harness sunlight to photocatalytically convert smog (NO, NO₂) into water-soluble ions (NO₃), actively reducing air pollution. Each average-size roof has the smog-fighting potential of ~2 trees.²

Upcycles Tires & Plastics – Polymers from recycled tires and plastic bags improve shingle strength and durability while reducing landfill waste. Anti-aging technology inherent in these materials adds even more protection from damaging UV sunlight. Each average-size roof diverts the equivalent of ~5 rubber tires and ~3,200 plastic bags from the landfill.¹

Cleaner Manufacturing – NEX® Technology results in much lower emissions than the highly-pollutive oxidation process used to make traditional shingles.

NEX[®] POLYMER MODIFIED ASPHALT TECHNOLOGY

Rubberized Asphalt Performs Better, Lasts Longer & is More Sustainable

Shingles are in a constant state of expansion and contraction caused by temperature changes and weather extremes. This constant movement stresses the shingle. Standard shingles struggle to keep up.

The reason is standard shingles are made with 100-year-old technology called oxidized asphalt, which uses oxygen and extreme heat to deliberately age (harden) the asphalt core of the shingle to raise its softening point so it doesn't melt on hot roofs.

This process is highly pollutive (TONS of annual air pollution) and has the adverse effect of significantly degrading asphalt's natural pliability, causing standard shingles to prematurely become brittle, crack, and lose hold of their protective granules.

Malarkey Roofing pioneered a better way. Instead of oxidation, we use polymers (molecular chains commonly found in rubber and plastic products) to create polymer modified asphalt (PMA). This process not only retains but enhances asphalt's natural weathering characteristics, chemically altering the asphalt core of the shingle to deliver the best properties of asphalt and rubber.

Our unique formulation combines high-grade asphalt with synthetic polymers, rubberizing the shingle for exceptional all-weather responsiveness, superior granule adhesion, and enhanced wind, rain, and impact resistance.

We also promote sustainable product design by incorporating 'upcycled' rubber and plastic polymers from used tires and plastic bags to further improve shingle strength, durability, and resilience, greatly extending shingle life, and helping prevent these materials from entering our landfills and oceans.

The result – **NEX[®] Polymer Modified Asphalt** – is a better, cleaner, more sustainable technology which fortifies every Malarkey shingle.

INNOVATION

NEX[®] POLYMER MODIFIED ASPHALT TECHNOLOGY [FORMULATION]

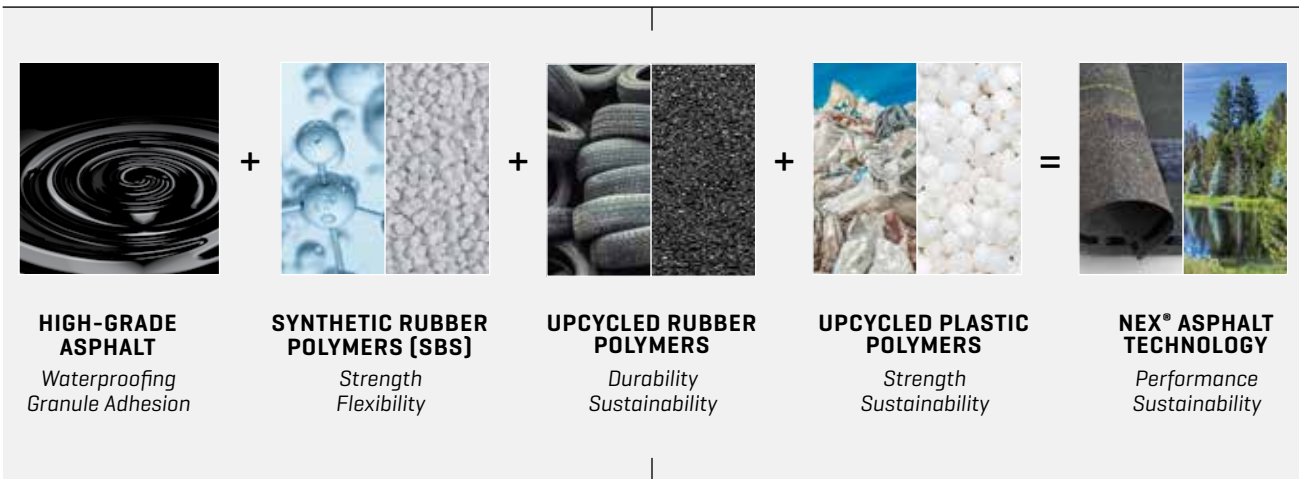

What is Upcycling?

Automobile tires are highly engineered for all-weather performance and durability – attributes also desired in shingles. By incorporating used tires, as well as post-consumer plastics, not only do we make our shingles more environmentally friendly by recycling these products, we also benefit from the advanced technology inherent in the products themselves, 'upcycling' these products to improve our own.

Each roof diverts the equivalent of ~5 rubber tires and ~3,200 plastic bags from the landfill.¹

THE INDUSTRY'S FIRST WIDER NAILING AREA

The Zone® Improves Installation Accuracy & Reduces Risk of Leaks

A standard roof requires over 6,000 properly placed nails. Even one out of place can lead to leaks, which is why we invented The Zone® for our architectural shingles. The Zone® has up to a 2x wider nailing area than standard shingles, and includes an extended shim on the back of the shingle. The larger shim improves the accuracy of each nail hitting and penetrating both shingle layers, critical for preventing shingle uplift, blow-off, and leaks. Double rain seals [twice that of standard shingles] add even more protection in this leak-prone area.

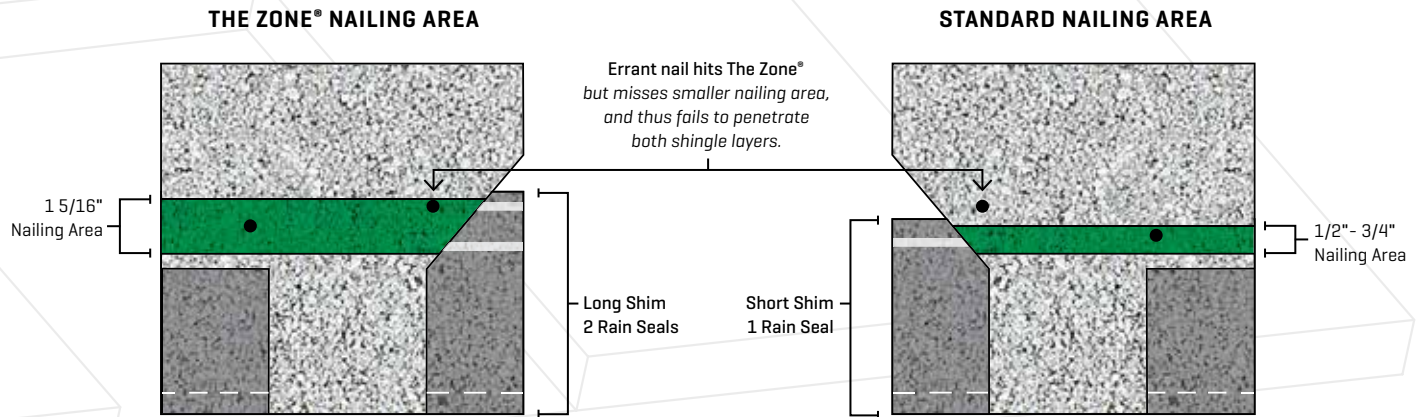

CRAFTSMANSHIP

THE ZONE® NAILING AREA [SIDE VIEW]

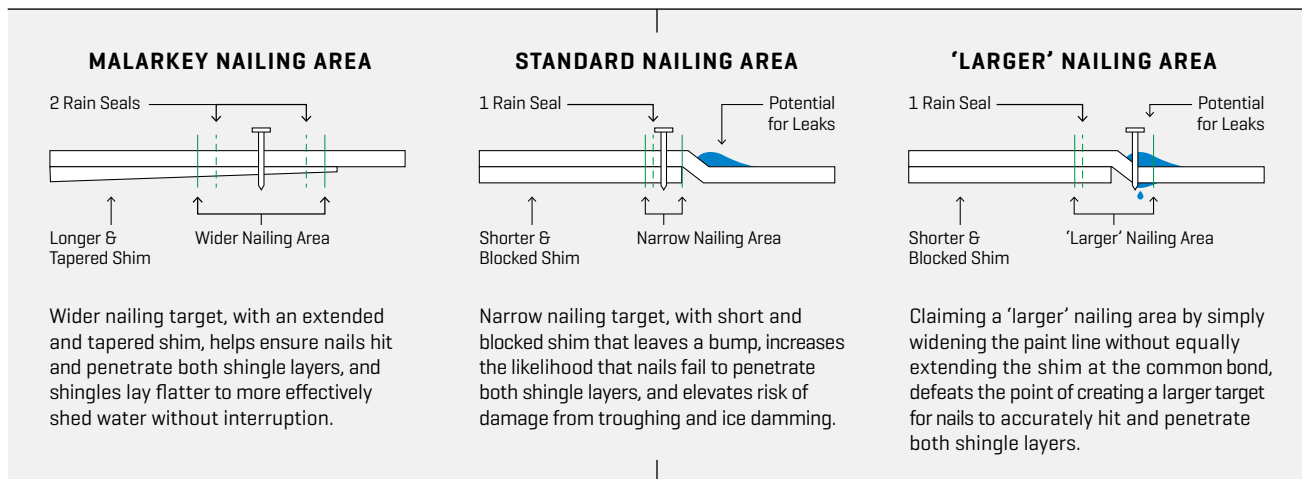

What is troughing and ice damming?

Troughing is when water runs sideways under shingles and then down a misplaced nail, resulting in leaks. Ice damming occurs when snow melts and refreezes at the roof edge forming a dam which prevents additional snow melt [water] from draining off the roof, instead creeping under shingles and leaking into the house.

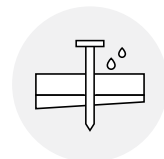

Misplaced nails are the most common reason for roof leaks and voided warranties.



Performance Ratings

Synthetic [SBS] and upcycled rubber and plastic polymers add durability, tear strength, and industry-leading impact protection from hail and storm debris.

Our Highlander® NEX®, Vista®, and Legacy™ shingle lines are Class 2, Class 3, and Class 4 impact rated [highest rating possible], respectively, by UL.

Our Vista® and Legacy™ shingle lines also meet the stringent FORTIFIED™ Roof requirements of the Insurance Institute for Business & Home Safety [IBHS].

RESILIENCE



POLYMER MODIFIED SHINGLES [OUTPERFORM IN HAIL]

STANDARD SHINGLES

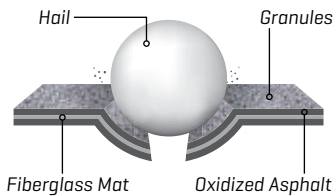

Standard shingles are rigid and stiff and thus lack the ability to adequately absorb force impact. They also maintain a weak grip on their protective granules, a double whammy when trying to withstand a major stress event like hail or storm debris.

SHINGLES WITH ADDED REINFORCEMENT

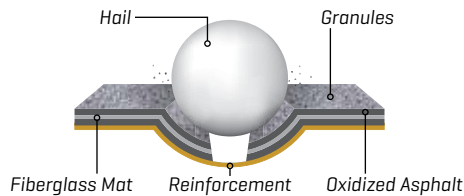

Some shingles include a reinforcement layer to help prevent/mask cracks in the asphalt on the back of the shingle in order to qualify for possible insurance discounts by passing the Class 4 impact test [UL 2218]. Unfortunately, this layer doesn't protect the top of the shingle from hail bruising, tears, or granule loss, leaving homeowners still stuck with the headache and expense [deductible] of replacing a hail-pitted roof.

MALARKEY SHINGLES

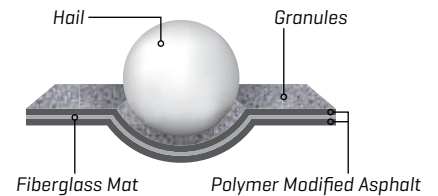

Polymer modified shingles like Malarkey's are rubberized to better deflect and withstand the force impact associated with hail and storm debris. Rubberization also greatly enhances granule adhesion, a shingle's first line of defense against impact.

How are Shingles Classified for Impact Resistance?



Shingles are classified for impact resistance in two ways – the IBHS *Hail Impact Study* and by UL [Underwriters Laboratories]. UL classifies shingles' impact resistance by dropping different-sized steel balls at various heights to simulate hail. Class 2, Class 3, and Class 4 rated shingles can withstand a 1 1/2", 1 3/4", and 2" ball dropped from 14', 17', and 20', respectively, without showing visible cracks on the back of the shingle.

Malarkey shingles often qualify for insurance discounts [contact your insurance agent].

The Industry's First SMOG-REDUCING SHINGLE

FEATURING 3M™ SMOG-REDUCING GRANULES
TIME MAGAZINE TOP 50 INVENTIONS OF 2018

Air quality is a concern for us all, which is why we created the industry's first smog-reducing shingle, using 3M™ Smog-Reducing Granules.

These granules, which blend inconspicuously into every shingle, harness sunlight to convert smog into water-soluble ions, actively reducing air pollution.



What is Smog?

Smog is a form of air pollution resulting from the interaction of UV sunlight with chemicals in the atmosphere like nitrogen oxides (NO_x) that get into the air primarily from the burning of fuel (ex. vehicle emissions).

As a gas, smog is easily inhaled, making it extremely hazardous to humans and animals, and can lead to severe health risks including lung tissue damage, bronchial infections, and heart problems.

ENVIRONMENT

SMOG-REDUCING GRANULE [HOW IT WORKS]

All Malarkey shingles include 3M™ Smog-Reducing Granules.

These granules contain a photocatalytic coating which, when activated by the UV rays of the sun, creates the energy needed to break apart airborne water molecules (ex. humidity) into their component parts (i.e., H_2O breaks into $\cdot\text{H}$ and $\cdot\text{OH}$).

The newly formed $\cdot\text{OH}$ molecule, called a hydroxyl radical, binds to smog molecules, chemically transforming them from a dangerous, inhalable gas (NO_2) into a water-soluble nitrate salt solid (NO_3), a more plant-usable form of nitrogen that washes away with rainwater.



3M™ Smog-Reducing Granules

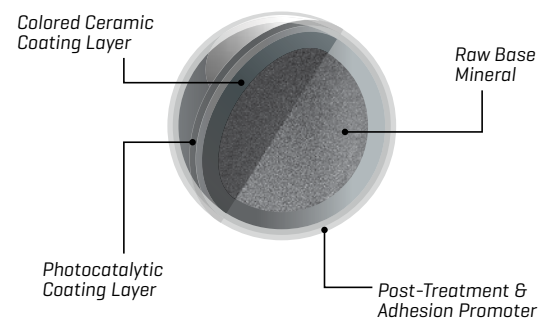

What Do Trees Have to Do with It?

Trees are nature's filters. Not only do they clean particulates out of the air by trapping them on leaves and bark, they also absorb pollutant gases like nitrogen oxides (NO_x) through leaf stomata. Stomata are small windows on green leaves that let carbon dioxide and other gaseous pollutants in and oxygen out. Like trees, Malarkey shingles also help fight air pollution by incorporating 3M™ Smog-Reducing Granules which convert smog gases into water soluble ions that settle on the roof and wash away with rainwater.



Each roof has the smog-fighting potential of ~2 trees.²



COLOR

Distributed from Portland, OR: [H] Highlander® NEX® AR [V] Vista® AR
Scotchgard™ Protector Lines include: [L] Legacy™ Scotchgard™ Protector



BLACK OAK: V, L



MIDNIGHT BLACK: H, V, L



STORM GREY: H, V, L



NATURAL WOOD: H, V, L



WEATHERED WOOD: H, V, L



HEATHER: V, L





One Roof at a Time

“Granted, it’s just one roof, but if everyone starts choosing a shingle that reduces landfill waste and also fights air pollution, who knows what the end result will be.”
– James Martinez, Homeowner

Matching colors available in high-profile EZ-Ridge™ XT as well as standard low-profile RidgeFlex™ hip and ridge shingles.



ANTIQUÉ BROWN: H, V, L



SIENNA BLEND: H, V, L



**SHOWN IN: VISTA® AR NATURAL WOOD [ABOVE];
HIGHLANDER® NEX® AR SILVERWOOD [BELOW]**



SILVERWOOD: H, V, L



**SHOWN IN:
VISTA® AR MIDNIGHT BLACK**



Black Streaks

Dew on roofs, combined with humidity and sunlight exposure, creates the perfect environment for algae growth which, on a roof, can cause unsightly staining in the form of black streaks that mar your roof's appearance and alter its color. In very humid environments, these streaks can manifest in as few as 3 years after installation, and they only get worse with time.

APPEARANCE

ALGAE-RESISTANT GRANULES

Mix of Copper-Coated Granules Impedes Algae Growth

To combat the problem of black streaks, we utilize copper-coated granules. These granules blend inconspicuously into the shingle's color, are uniformly distributed on the shingle's surface, and release copper ions which inhibit algae growth, preventing it from getting started in the first place.

ALGAE-RESISTANT TECHNOLOGY [HOW IT WORKS]



For maximum algae protection, our shingles featuring Scotchgard™ Protector utilize at least a 10% blend of 3M™ Copper Granules.

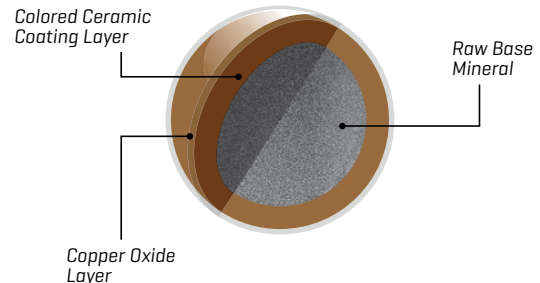

Why Not Just Clean the Roof to Get Rid of Black Streaks?

Climbing on the roof and attempting to remove black streaks caused by algae growth via pressure washing is dangerous and can damage your roof by dislodging the shingle's granules, their primary defense against damage and UV aging.

Malarkey was the first shingle manufacturer to receive the Scotchgard™ Protector designation from 3M.



Heritage

“We will value fair and honest dealings with our customers, will commit ourselves to the highest quality standards, and will take care of the communities in which we operate.”

*Herbert Malarkey
Founder, Malarkey Roofing Products*

ABOUT US

GOING STRONG SINCE 1956

Built by Family, Installed by Experts

Malarkey is a family business based in Portland, Oregon since 1956, with three manufacturing plants located in Oregon, California, and Oklahoma. We make the shingles we want on our own homes, and we're proud to lead the industry in innovation and sustainability.

Cleaner Energy

Malarkey received the Governor's Award for *Outstanding Achievements in Energy Conservation* for diverting methane gas from a nearby water treatment plant to power our manufacturing facility.

Cleaner Manufacturing

Malarkey pioneered polymer modified shingle making – a much cleaner technology that also results in a longer lasting (more sustainable) product. Malarkey is GreenCircle Certified for *Waste Diversion from Landfill & Recycled Content*.

Cleaner Land

By incorporating upcycled rubber and plastic polymers into our asphalt formulation, Malarkey has diverted the equivalent of **4.1M tires** and **2.8B plastic bags** from the landfill.

Cleaner Air

By integrating smog-reducing granules onto our shingles, Malarkey has 'planted' the equivalent of **920K trees** to help clean the air of emission pollutants.

*Shingles made cleaner, greener, and to last longer.
That's the goal...one roof at a time.*

Industry Innovations

1986

FIRST Polymer Modified (SBS) Shingle in North America

1993

FIRST to Meet Miami Dade County Wind Requirement

2001

FIRST Wider Nailing Area (The Zone®)

2003

FIRST 3M Scotchgard™ Protector Algae Designation

2016

FIRST Use of Recycled Polymers in Polymer Modified (SBS) Shingles

2018

FIRST Smog-Reducing Shingle

Architectural Shingles Comparison Chart

VERY GOOD

BETTER

BEST

HIGHLANDER[®]
NEX[®] AR

VISTA[®]
AR

LEGACY[™] SCOTCHGARD[™]
PROTECTOR

Asphalt Technology

NEX[®]

NEX[®]

NEX[®]

Impact Rating [Class 4 Highest]

Class 2

Class 3

Class 4

Tear Strength*

+10%

+25%

+35%

Thickness

+10%

+19%

Sustainability [assumes roof of 30 squares]

~Upcycled Rubber Tires

4

5

6

~Upcycled Plastic Bags

2,900

3,200

4,000

~Trees 'Planted'²

2

2

2

Cost

\$

\$\$

\$\$\$

Warranties⁺

Limited Lifetime Shingle Warranty

Lifetime

Lifetime

Lifetime

Right Start[™] Non-Prorated Period [years]

10

12

15

'Your Choice' Warranty³

Yes

Yes

Yes

Streak Resist[™] AR Algae Warranty [years]

10

12

NA

Limited Lifetime Algae Warranty^{**}

NA

NA

Lifetime

Standard Wind Warranty [mph/kph/years]

110/177/10

110/177/12

110/177/15

Enhanced Wind Warranty [mph/kph/years]

130/209/10

130/209/12

130/209/15

*VERSUS STANDARD SHINGLES, AS MEASURED PER ASTM D3462.

**INCLUDED ON SHINGLES WITH SCOTCHGARD[™] PROTECTOR.

CHOICE

Malarkey Roofing Products[®] has earned GreenCircle Certification for Waste Diversion from Landfill at all its manufacturing facilities.

Testimonials

"As one of the largest roofing companies in Alaska, we know extreme weather, which is why Malarkey has been at the core of our product offering for over 30 years."

– Pat Reilly, Owner, Rain Proof Roofing

"Last week, with winds up to 68 mph, we had over 100 calls for shingles blown off of roofs in our area yet didn't lose a single shingle from our Malarkey shingle line. They are made for these conditions."

– Jeremy Nowak, President, Bob's Roofing



¹ Assumes roof of 30 squares using Vista[®] shingles.

² Assumes roof of 30 squares. Source: Lawrence Berkeley National Laboratory and 3M.

³ Select our transferable Limited Lifetime Shingle Warranty or one from a competitor - your choice.

TEST COMPLIANCE: All Shingles - ASTM D7158 Class H, ASTM D3462, ASTM D3161 Class F, ASTM D3018 Type I, ASTM E108 Class A Fire Rating, CSA A123.5, ICC Approval - ESR-3150, ICC-ES AC438 and FBC Approval #14809. UL 2218 Class 4 [Legacy[™] line], UL 2218 Class 3 [Vista[™] line], UL 2218 Class 2 [Highlander[®] NEX[®] line].

DISCLAIMER: Photographs of shingles may not accurately represent their true color or the variations of color blends that will appear on the roof. Before installation, five or six shingles should be laid out and reviewed for desired color. Colors and specifications subject to change without notice. Shingle colors not available in all regions or product lines. Scotchgard and Scotchgard Protector, including the 3M logo, are all trademarks of 3M.

+ For complete information on all warranties, including 'Your Choice' Warranty and the Right Start[™] non-prorated period against manufacturing defects, please reference Malarkey's Shingle and Accessory Warranty available at www.malarkeyroofing.com/warranties.

This version supersedes all previous versions. Rev. 01/22.



P.O. Box 17217
Portland, Oregon 97217
800.545.1191
www.malarkeyroofing.com

MEETS CSA A123.5
STANDARDS

MADE IN USA